



**TECHNO**  
**TFIX**  
FIJACIONES FIXINGS

## CATÁLOGO

**TFIX**  
*Solutions*



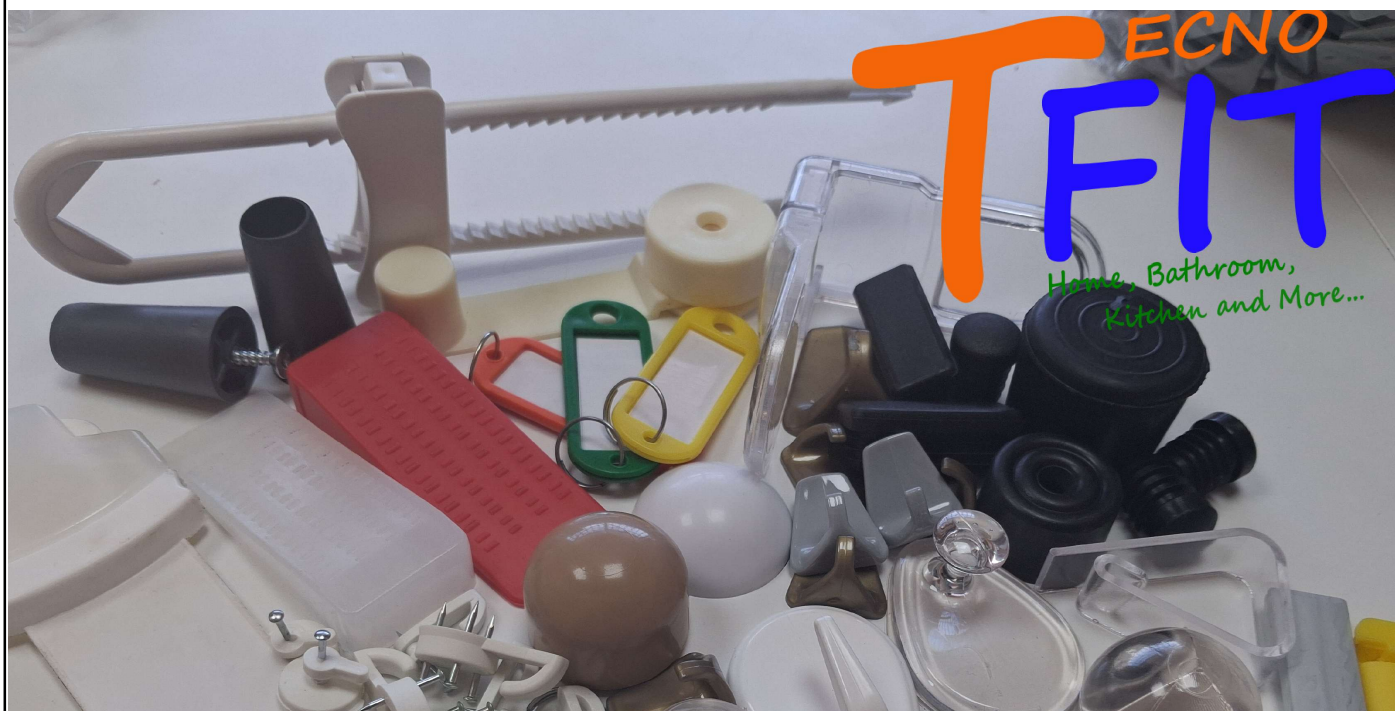

C/ PLA DE FOIOS,21  
POL. IND. 3  
46113 MONCADA (VALENCIA)  
ESPAÑA  
TELÉFONO: +34 610 085 442  
EMAIL: [tfix@tfixsolutions.com](mailto:tfix@tfixsolutions.com)  
WEB: [www.tfixsolutions.com](http://www.tfixsolutions.com)



# ÍNDICE













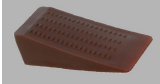

## TECHNOFIX

<u>NYLON FIX</u>	<u>NX</u>		<b>1-1-1</b>
	<u>SB</u>		<b>1-1-4</b>
	<u>CB</u>		<b>1-1-7</b>
	<u>NF</u>		<b>1-1-10</b>
	<u>TP</u>		<b>1-1-11</b>
			
<u>METAL FIX</u>	<u>MT</u>		<b>1-2-1</b>
			
<u>SERIE LARGA</u>	<u>TFA</u>		<b>1-3-1</b>
			
<u>BRIDA FIX</u>	<u>BF</u>		<b>2-1-1</b>
			

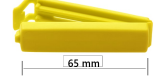

## TECNOFIT

<u>CUELGA FIX</u>			<b>3-1-1</b>
<u>CORTINAS</u>			<b>3-2-1</b>
<u>TOPES PUERTA</u>			<b>3-3-1</b>
<u>PROTECTOR ADHESIVO</u>			<b>3-4-1</b>
<u>VARIOS</u>			<b>3-4-1</b>
<u>PROTECCION INFANTIL Y MAYORES</u>			<b>3-5-1</b>
<u>CONTERAS</u>			<b>3-6-1</b>

# NYLON FIX NX



## Tech INFO

**Premium NYLON Quality**

**MATERIAL**

**INSTALACIÓN**

REF.									
	Ø mm	L mm	øT mm	LT mm					
NX-5	5	25	4	30	30	16	12	4	20
NX-6	6	30	4.5	40	65	22	15	5	30
NX-8	8	40	5	50	75	42	21	8	40
NX-10	10	50	6	60	125	80	40	10	45
NX-12	12	60	8	70	175	150	65	10	50
NX-14	14	70	10	80	200	165	80	10	55

<b>NX</b>	
<b>NXZ</b>	
<b>NXE</b>	

<b>NXA</b>		+	
<b>NXO</b>		+	
<b>NXC</b>		+	

## ENVASE

<b>S-Box</b>		<b>M-Box</b>		<b>L-Box</b>		<b>P-Box</b>		<b>B-Box</b>		<b>H-Box</b>		<b>Blister</b>		<b>Bolsa</b>	
--------------	--	--------------	--	--------------	--	--------------	--	--------------	--	--------------	--	----------------	--	--------------	--

# NYLON FIX NX

REF.	ENVASE	COD.	Uds.
NX-5	S-Box	NX005010	75
	M-Box	NX005020	200
	L-Box	NX005030	400
	P-Box	NX005040	800
	B-Box	NX005050	2500
	H-Box	NX005060	5500
	Blister	NX005070	16
	Bolsa	NX005080	20

REF.	ENVASE	COD.	Uds.
NX-6	S-Box	NX006010	50
	M-Box	NX006020	100
	L-Box	NX006030	200
	P-Box	NX006040	800
	B-Box	NX006050	2000
	H-Box	NX006060	4500
	Blister	NX006070	10
	Bolsa	NX006080	10

REF.	ENVASE	COD.	Uds.
NX-8	S-Box	NX008010	20
	M-Box	NX008020	50
	L-Box	NX008030	100
	P-Box	NX008040	200
	B-Box	NX008050	700
	H-Box	NX008060	1400
	Blister	NX008070	10
	Bolsa	NX008080	8

REF.	ENVASE	COD.	Uds.
NX-10	M-Box	NX105020	25
	L-Box	NX105030	50
	P-Box	NX105040	100
	B-Box	NX105050	400
	H-Box	NX105060	800
	Blister	NX105070	10
	Bolsa	NX105080	4

REF.	ENVASE	COD.	Uds.
NX-12	L-Box	NX012030	25
	P-Box	NX012040	50
	B-Box	NX012050	250
	H-Box	NX012060	500
	Blister	NX012070	6

REF.	ENVASE	COD.	Uds.
NX-14	P-Box	NX014040	50
	B-Box	NX014050	200
	H-Box	NX014060	400

## NYLON FIX NXZ

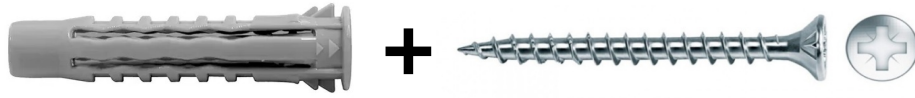

REF.	NX	+ Z			
		d	L	D	PZ
NXZ-5	NX-5	4	30	8	2
NXZ-6	NX-6	4.5	40	9	2
NXZ-8	NX-8	5	50	10	2
NXZ-10	NX-10	6	60	12	3

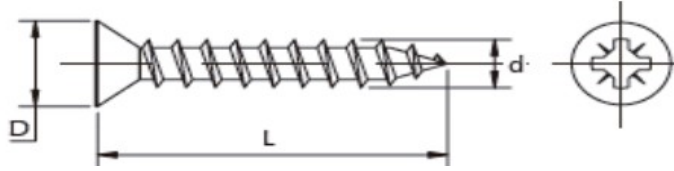

REF.	ENVASE	COD.	Uds.
NXZ-5	S-Box	NZ005010	25
	Blister	NZ005070	16
	Bolsa	NZ005080	10
NXZ-6	S-Box	NZ006010	25
	M-Box	NZ006020	60
	Blister	NZ006070	10
	Bolsa	NZ006080	10

REF.	ENVASE	COD.	Uds.
NXZ-8	S-Box	NZ008010	10
	M-Box	NZ008020	30
	L-Box	NZ008030	60
	Blister	NZ008070	6
	Bolsa	NZ008080	6

REF.	ENVASE	COD.	Uds.
NXZ-10	L-Box	NZ105030	30
	Blister	NZ105070	4
	Bolsa	NZ105080	2

## NYLON FIX NXE



REF.	NX	+ W			+ E				
		d	D	e	d	L	K	S	Q
NXE-8	NX-8	5.3	10	1	5	50	3	8	6.8
NXE-10	NX-10	6.4	12.5	1.6	6	60	4	10	8.8
NXE-12	NX-12	8.4	17	1.6	8	70	5.5	13	8.8
NXE-14	NX-14	10.5	21	2	10	80	7	17	8.8

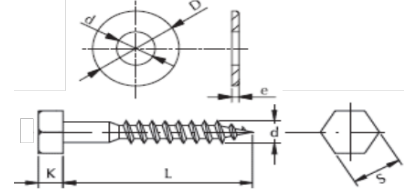

REF.	ENVASE	COD.	Uds.
NXE-8	S-Box	NE008010	15
	Blister	NE008070	4
	Bolsa	NE008080	6

REF.	ENVASE	COD.	Uds.
NXE-10	M-Box	NE105020	15
	Blister	NE105070	2
	Bolsa	NE105080	4

REF.	ENVASE	COD.	Uds.
NXE-12	Blister	NE012070	2
	Bolsa	NE012080	4
NXE-14	Bolsa	NE014080	2

## NYLON FIX NXA



REF.	NX	+ A				
		Ø D	Ø d	d2	L	L2
NXA-5	NX-5	3.8	3	16	35	18
NXA-6	NX-6	4.5	3,5	18	45	20
NXA-8	NX-8	5	4	19	55	25
NXA-10	NX-10	6	5	28	80	35

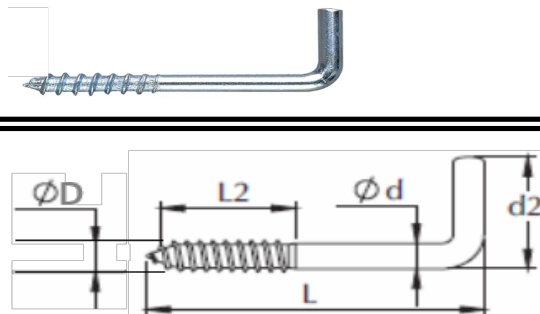

REF.	ENVASE	COD.	Uds.
NXA-5	Blister	NA005070	16
	Bolsa	NA005080	8
NXA-6	Blister	NA006070	10
	Bolsa	NA006080	8

REF.	ENVASE	COD.	Uds.
NXA-8	S-Box	NA008010	6
	M-Box	NA008020	4
	Blister	NA008070	4

REF.	ENVASE	COD.	Uds.
NXA-10	S-Box	NA105010	5
	Blister	NA105070	4
	Bolsa	NA105080	2

## NYLON FIX NXO



REF.	NX	+ O				
		Ø D	Ø d	d2	L	L2
NXO-5	NX-5	3.8	3	7	36	18
NXO-6	NX-6	4.5	3.5	9	43	20
NXO-8	NX-8	5	4	10	59	40
NXO-10	NX-10	6	5	16.5	79	45

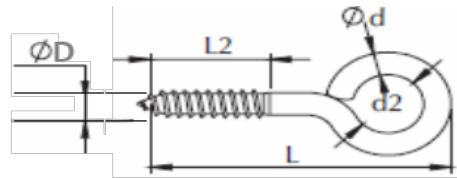

REF.	ENVASE	COD.	Uds.
NXO-5	Blister	NO005070	10
	Bolsa	NO005080	8
NXO-6	Blister	NO006070	5
	Bolsa	NO006080	8

REF.	ENVASE	COD.	Uds.
NXO-8	Blister	NO008070	6
	Bolsa	NO008080	4
NXO-10	Blister	NO105070	2
	Bolsa	NO105080	2

## NYLON FIX NXC



REF.	NX	+ C				
		Ø D	Ø d	d2	L	L2
NXC-5	NX-5	3.8	3	7	36	18
NXC-6	NX-6	4.5	3.5	9	43	20
NXC-8	NX-8	5	4	10	59	40
NXC-10	NX-10	6	5	16.5	79	45

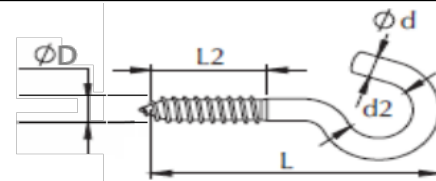

REF.	ENVASE	COD.	Uds.
NXC-5	Blister	NC005070	16
	Bolsa	NC005080	8
NXC-6	Blister	NC006070	10
	Bolsa	NC006080	8

REF.	ENVASE	COD.	Uds.
NXC-8	Blister	NC008070	6
	Bolsa	NC008080	4
NXC-10	Blister	NC105070	2
	Bolsa	NC105080	2

## DUO-BLISTER PACKS

	REF. A	REF. B	COD.	Uds A	Uds B
	NX-5	NX-6	NX056100	16	10
	NX-6	NX-8	NX068100	10	5
	NX-8	NX-10	NX810100	10	6
	NXA-5	NXO-5	NX055100	10	10
	NXA-6	NXO-6	NX066100	5	5
	NXA-8	NXO-8	NX088100	4	4
	NXA-10	NXO-10	NX101100	2	2

# NYLON FIX SB



## Tech INFO

**Premium NYLON Quality**

**MATERIAL**

**INSTALACIÓN**

REF.					MAX Kg	MAX Kg	MAX Kg	MAX Kg
	Ø mm	L mm	ØT mm	LT mm				
SB-4	4	20	2.5	25	8	4	3	4
SB-5	5	25	3	30	21	15	12	20
SB-6	6	30	4	40	33	25	15	25
SB-7	7	30	4.5	40	40	30	20	35
SB-8	8	40	5	50	45	40	25	45
SB-10	10	50	6	60	90	45	30	50
SB-12	12	60	8	70	115	50	---	55
SB-14	14	70	10	80	145	---	---	70
SB-16	16	80	12	90	180	---	---	---

SB	
SBZ	
SBE	

SBA	
SBO	
SBC	

## PACK

S-Box		M-Box		L-Box		P-Box		B-Box		H-Box		Blister		Bolsa	
-------	--	-------	--	-------	--	-------	--	-------	--	-------	--	---------	--	-------	--

## NYLON FIX SB

REF.	ENVASE	COD.	Uds.
SB-4	S-Box	SB004010	200
	M-Box	SB004020	400
	P-Box	SB004040	2000
	B-Box	SB004050	6000
	H-Box	SB004060	14000
	Blister	SB004070	20
	Bolsa	SB004080	30
SB-5	S-Box	SB005010	100
	M-Box	SB005020	200
	L-Box	SB005030	500
	P-Box	SB005040	1000
	B-Box	SB005050	3000
	H-Box	SB005060	7000
	Blister	SB005070	16
SB-6	S-Box	SB006010	50
	M-Box	SB006020	100

REF.	ENVASE	COD.	Uds.
SB-6	L-Box	SB006030	200
	P-Box	SB006040	400
	B-Box	SB006050	2000
	H-Box	SB006060	4000
	Blister	SB006070	10
	Bolsa	SB006080	10
	L-Box	SB007030	100
SB-7	P-Box	SB007040	200
	B-Box	SB007050	1500
	H-Box	SB007060	3000
SB-8	M-Box	SB008020	50
	L-Box	SB008030	100
	P-Box	SB008040	250
	B-Box	SB008050	1000
	H-Box	SB008060	2000
	Blister	SB008070	8
Bolsa	SB008080	8	

REF.	ENVASE	COD.	Uds.
SB-10	M-Box	SB010020	25
	L-Box	SB010030	50
	P-Box	SB010040	150
	B-Box	SB010050	400
	H-Box	SB010060	800
	Blister	SB010070	8
	Bolsa	SB010080	6
SB-12	L-Box	SB012030	30
	P-Box	SB012040	60
	B-Box	SB012050	300
	H-Box	SB012060	600
SB-14	P-Box	SB014040	50
	B-Box	SB014050	200
SB-16	H-Box	SB014060	400
	P-Box	SB016040	50
	B-Box	SB016050	100
H-Box	SB016060	200	

## NYLON FIX SBZ

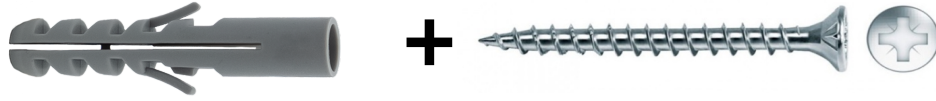

REF.	SB	+ Z			
		d	L	D	PZ
SBZ-4	SB-4	2.5	25	5	1
SBZ-5	SB-5	3.5	35	7	2
SBZ-6	SB-6	4	40	8	2
SBZ-8	SB-8	5	50	10	2
SBZ-10	SB-10	6	60	12	3

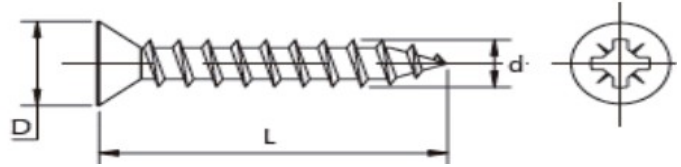

REF.	ENVASE	COD.	Uds.
SBZ-4	Blister	SZ004070	20
	Bolsa	SZ004080	12
SBZ-5	Blister	SZ005070	16
	Bolsa	SZ005080	10

REF.	ENVASE	COD.	Uds.
SBZ-6	S-Box	SZ006010	25
	M-Box	SZ006020	60
	Blister	SZ006070	10
	Bolsa	SZ006080	8

REF.	ENVASE	COD.	Uds.
SBZ-8	M-Box	SZ008020	30
	Blister	SZ008070	10
	Bolsa	SZ008080	4
SBZ-10	Blister	SZ010070	8
	Bolsa	SZ010080	2

## NYLON FIX SBE

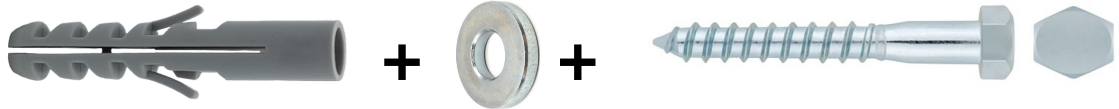

REF.	SB	+ W			+ E				
		d	D	e	d	L	K	S	Q
SBE-8	SB-8	5.3	10	1	5	50	3	8	6.8
SBE-10	SB-10	6.4	12.5	1.6	6	60	4	10	8.8
SBE-12	SB-12	8.4	17	1.6	8	70	5.5	13	8.8
SBE-14	SB-14	10.5	21	2	10	80	7	17	8.8

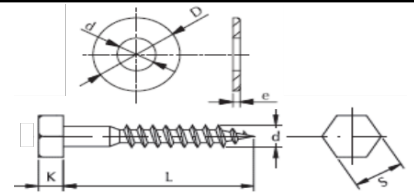

REF.	ENVASE	COD.	Uds.
SBE-8	S-Box	SE008010	15
	Blister	SE008070	6
	Bolsa	SE008080	6

REF.	ENVASE	COD.	Uds.
SBE-10	M-Box	SE010020	15
	Blister	SE010070	4
	Bolsa	SE010080	4

REF.	ENVASE	COD.	Uds.
SBE-12	Blister	SE012070	2
	Bolsa	SE012080	4
SBE-14	Bolsa	SE014080	2

## NYLON FIX SBA



REF.	SB	+ A				
		Ø D	Ø d	d2	L	L2
SBA-4	SB-4	3	2.4	12	25	11
SBA-5	SB-5	3.5	2.7	15	35	18
SBA-6	SB-6	3.8	3	16	40	18
SBA-7	SB-7	4.5	3.5	18	45	20
SBA-8	SB-8	5	4	19	55	25
SBA-10	SB-10	6	5	28	80	35

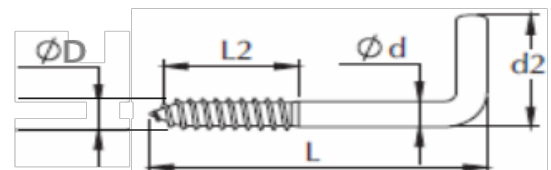

REF.	ENVASE	COD.	Uds.
SBA-4	Blister	SA004070	16
	Bolsa	SA004080	12
SBA-5	Blister	SA005070	12
	Bolsa	SA005080	8

REF.	ENVASE	COD.	Uds.
SBA-6	Blister	SA006070	10
	Bolsa	SA006080	8
SBA-7	Blister	SA007070	8
	Bolsa	SA007080	6

REF.	ENVASE	COD.	Uds.
SBA-8	Blister	SA008070	6
	Bolsa	SA008080	4
SBA-10	Blister	SA010070	4
	Bolsa	SA010080	2

## NYLON FIX SBO



REF.	SB	+ A				
		Ø D	Ø d	d2	L	L2
SBO-4	SB-4	3	2.4	12	25	11
SBO-5	SB-5	3.5	2.7	15	35	18
SBO-6	SB-6	3.8	3	16	40	18
SBO-7	SB-7	4.5	3.5	18	45	20
SBO-8	SB-8	5	4	19	55	25
SBO-10	SB-10	6	5	28	80	35

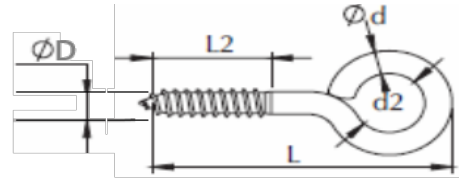

REF.	ENVASE	COD.	Uds.
SBO-4	Blister	SO004070	16
	Bolsa	SO004080	12
SBO-5	Blister	SO005070	12
	Bolsa	SO005080	8

REF.	ENVASE	COD.	Uds.
SBO-6	Blister	SO006070	10
	Bolsa	SO006080	8
SBO-7	Blister	SO007070	8
	Bolsa	SO007080	6

REF.	ENVASE	COD.	Uds.
SBO-8	Blister	SO008070	6
	Bolsa	SO008080	4
SBO-10	Blister	SO010070	4
	Bolsa	SO010080	2

## NYLON FIX SBC



REF.	SB	+ A				
		Ø D	Ø d	d2	L	L2
SBC-4	SB-4	3	2.4	12	25	11
SBC-5	SB-5	3.5	2.7	15	35	18
SBC-6	SB-6	3.8	3	16	40	18
SBC-7	SB-7	4.5	3.5	18	45	20
SBC-8	SB-8	5	4	19	55	25
SBC-10	SB-10	6	5	28	80	35

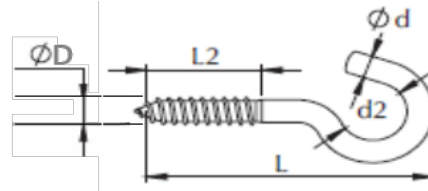

REF.	ENVASE	COD.	Uds.
SBC-4	Blister	SC004070	16
	Bolsa	SC004080	12
SBC-5	Blister	SC005070	12
	Bolsa	SC005080	8

REF.	ENVASE	COD.	Uds.
SBC-6	Blister	SC006070	10
	Bolsa	SC006080	8
SBC-7	Blister	SC007070	8
	Bolsa	SC007080	6

REF.	ENVASE	COD.	Uds.
SBC-8	Blister	SC008070	6
	Bolsa	SC008080	4
SBC-10	Blister	SC010070	4
	Bolsa	SC010080	2

## DUO-BLISTER PACKS

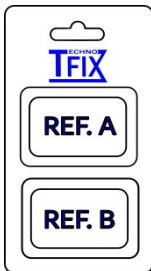
	REF. A	REF. B	COD.	Uds A	Uds B
	SB-4	SB-5	SB045100	20	16
	SB-5	SB-6	SB056100	16	10
	SB-6	SB-8	SB068100	10	8
	SB-8	SB-10	SB810100	8	8
	SBA-4	SBO-4	SB044100	16	16
	SBA-5	SBO-5	SB055100	12	12
	SBA-6	SBO-6	SB066100	10	10
	SBA-8	SBO-8	SB088100	6	6
	SBA-10	SBO-10	SB101100	4	4

# NYLON FIX CB



## Tech INFO

Premium NYLON Quality

**MATERIAL**

**INSTALACIÓN**

REF.								
	Ø mm	L mm	ØT mm	LT mm				
CB-5	5	25	3	30	21	15	12	20
CB-6	6	30	4	40	33	25	15	25
CB-8	8	40	5	50	45	40	25	45
CB-7	7	30	4.5	40	40	30	20	35
CB-10	10	50	6	60	90	45	30	50
CB-12	12	60	8	70	115	50	---	55
CB-14	14	70	10	80	145	---	---	70

CB	
CBZ	
CBE	

CBA		+	
CBO		+	
CBC		+	

## PACK

S-Box		M-Box		L-Box		P-Box		B-Box		H-Box		Blister		Bolsa	
-------	--	-------	--	-------	--	-------	--	-------	--	-------	--	---------	--	-------	--

# NYLON FIX CB

REF.	ENVASE	COD.	Uds.
CB-5	S-Box	CB005010	100
	M-Box	CB005020	200
	L-Box	CB005030	500
	P-Box	CB005040	1000
	B-Box	CB005050	3000
	H-Box	CB005060	7000
	Blister	CB005070	16
CB-6	S-Box	CB006010	50
	M-Box	CB006020	100
	L-Box	CB006030	250
	P-Box	CB006040	500
	B-Box	CB006050	2000
	H-Box	CB006060	4000

REF.	ENVASE	COD.	Uds.
CB-6	Blister	CB006070	10
	Bolsa	CB006080	15
CB-7	L-Box	CB007030	100
	P-Box	CB007040	200
	B-Box	CB007050	1500
CB-8	H-Box	CB007060	3000
	S-Box	CB008010	25
	M-Box	CB008020	50
	L-Box	CB008030	100
	P-Box	CB008040	250
	B-Box	CB008050	1000
	H-Box	CB008060	2000
CB-8	Blister	CB008070	8
	Bolsa	CB008080	8

REF.	ENVASE	COD.	Uds.
CB-10	M-Box	CB010020	25
	L-Box	CB010030	50
	P-Box	CB010040	150
	B-Box	CB010050	400
	H-Box	CB010060	800
CB-12	Blister	CB010070	8
	Bolsa	CB010080	6
	L-Box	CB012030	30
CB-12	P-Box	CB012040	60
	B-Box	CB012050	300
	H-Box	CB012060	600
CB-14	P-Box	CB014040	150
	B-Box	CB014050	200
CB-14	H-Box	CB014060	400

## NYLON FIX CBZ

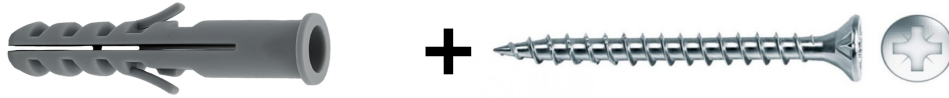

REF.	CB	+ Z			
		d	L	D	PZ
CBZ-5	CB-5	3.5	35	7	2
CBZ-6	CB-6	4	40	8	2
CBZ-8	CB-8	5	50	10	2
CBZ-10	CB-10	6	60	12	3

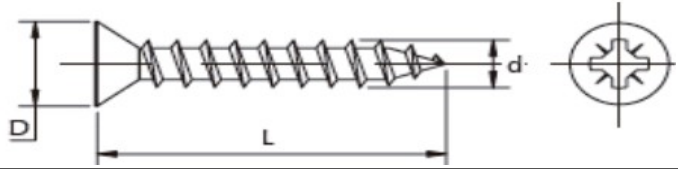

REF.	ENVASE	COD.	Uds.
CBZ-5	Blister	CZ005070	16
	Bolsa	CZ005080	10
CBZ-6	S-Box	CZ006010	25
	M-Box	CZ006020	60

REF.	ENVASE	COD.	Uds.
CBZ-6	Blister	CZ006070	10
	Bolsa	CZ006080	8
CBZ-8	M-Box	CZ008020	30

REF.	ENVASE	COD.	Uds.
CBZ-8	Blister	CZ008070	10
	Bolsa	CZ008080	4
CBZ-10	Blister	CZ010070	8
	Bolsa	CZ010080	2

## NYLON FIX CBE



REF.	CB	+ W			+ E				
		d	D	e	d	L	K	S	Q
CBE-8	CB-8	5.3	10	1	5	50	3	8	6.8
CBE-10	CB-10	6.4	12.5	1.6	6	60	4	10	8.8
CBE-12	CB-12	8.4	17	1.6	8	70	5.5	13	8.8
CBE-14	CB-14	10.5	21	2	10	80	7	17	8.8

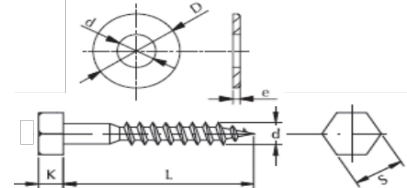

REF.	ENVASE	COD.	Uds.
CBE-8	S-Box	CE008010	15
	Blister	CE008070	6
	Bolsa	CE008080	6

REF.	ENVASE	COD.	Uds.
CBE-10	M-Box	CE010020	15
	Blister	CE010070	4
	Bolsa	CE010080	4

REF.	ENVASE	COD.	Uds.
CBE-12	Blister	CE012070	2
	Bolsa	CE012080	4
CBE-14	Bolsa	CE014080	2

## NYLON FIX CBA



REF.	CB	+ A				
		Ø D	Ø d	d2	L	L2
CBA-5	CB-5	3.5	2.7	15	35	18
CBA-6	CB-6	3.8	3	16	40	18
CBA-7	CB-7	4.5	3.5	18	45	20
CBA-8	CB-8	5	4	19	55	25
CBA-10	CB-10	6	5	28	80	35

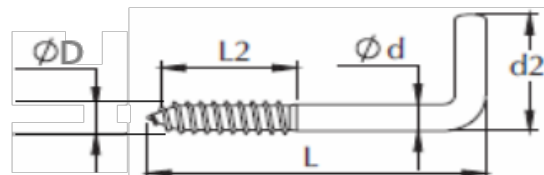

REF.	ENVASE	COD.	Uds.
CBA-5	Blister	CA005070	12
	Bolsa	CA005080	8
CBA-6	Blister	CA006070	10
	Bolsa	CA006080	8

REF.	ENVASE	COD.	Uds.
CBA-7	Blister	CA007070	8
	Bolsa	CA007080	6

REF.	ENVASE	COD.	Uds.
CBA-8	Blister	CA008070	6
	Bolsa	CA008080	4
CBA-10	Blister	CA010070	4
	Bolsa	CA010080	2

## NYLON FIX CBO



REF.	CB	+ A				
		Ø D	Ø d	d2	L	L2
CBO-5	CB-5	3.5	2.7	15	35	18
CBO-6	CB-6	3.8	3	16	40	18
CBO-7	CB-7	4.5	3.5	18	45	20
CBO-8	CB-8	5	4	19	55	25
CBO-10	CB-10	6	5	28	80	35

REF.	ENVASE	COD.	Uds.
CBO-5	Blister	CO005070	12
	Bolsa	CO005080	8
CBO-6	Blister	CO006070	10
	Bolsa	CO006080	8

REF.	ENVASE	COD.	Uds.
CBO-7	Blister	CO007070	8
	Bolsa	CO007080	6

REF.	ENVASE	COD.	Uds.
CBO-8	Blister	CO008070	6
	Bolsa	CO008080	4
CBO-10	Blister	CO010070	4
	Bolsa	CO010080	2

## NYLON FIX CBC

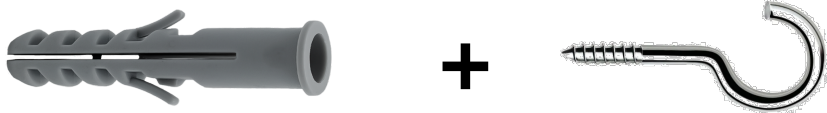

REF.	CB	+ A				
		Ø D	Ø d	d2	L	L2
CBC-5	CB-5	3.5	2.7	15	35	18
CBC-6	CB-6	3.8	3	16	40	18
CBC-7	CB-7	4.5	3.5	18	45	20
CBC-8	CB-8	5	4	19	55	25
CBC-10	CB-10	6	5	28	80	35

REF.	ENVASE	COD.	Uds.
CBC-5	Blister	CC005070	12
	Bolsa	CC005080	8
CBC-6	Blister	CC006070	10
	Bolsa	CC006080	8

REF.	ENVASE	COD.	Uds.
CBC-7	Blister	CC007070	8
	Bolsa	CC007080	6

REF.	ENVASE	COD.	Uds.
CBC-8	Blister	CC008070	6
	Bolsa	CC008080	4
CBC-10	Blister	CC010070	4
	Bolsa	CC010080	2

## DUO-BLISTER PACKS

REF. A	REF. B	COD.	Uds A	Uds B
CB-5	CB-6	CB056100	16	10
CB-6	CB-8	CB068100	10	8
CB-8	CB-10	CB810100	8	8
CBA-5	CBO-5	CB055100	12	12
CBA-6	CBO-6	CB066100	10	10
CBA-8	CBO-8	CB088100	6	6
CBA-10	CBO-10	CB101100	4	4

# NYLON FIX NF

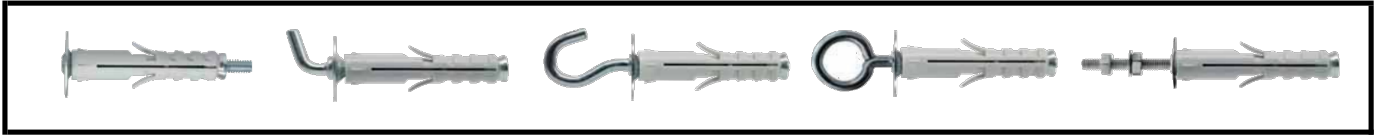

<b>NFT</b>		<b>NFA</b>		<b>NFL</b>	
<b>NFE</b>		<b>NFO</b>		<b>NFC</b>	

## Tech INFO

### MATERIAL



### INSTALACIÓN

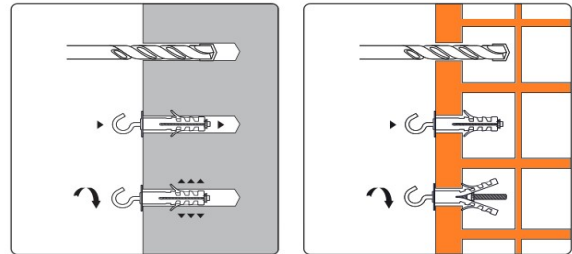

REF.								
	Ø mm	L mm	M	A mm				
NF_9	9	40	4	20	45	40	35	35
NF_12	12	45	5	24	80	50	45	45

## NF - PACK

<b>M-Box</b>		<b>L-Box</b>		<b>P-Box</b>		<b>Blister</b>		<b>Bolsa</b>	
--------------	--	--------------	--	--------------	--	----------------	--	--------------	--

REF.	ENVASE	COD.	Uds.
<b>NFT-9</b>	L-Box	NT009030	50
	Blister	NT009070	4
	Bolsa	NT009080	2
<b>NFA-9</b>	L-Box	NA009030	50
	Blister	NA009070	2
	Bolsa	NA009080	2
<b>NFL-9</b>	L-Box	NL009030	25
	Blister	NL009070	2
	Bolsa	NL009080	2
<b>NFO-9</b>	L-Box	NO009030	25
	Blister	NO009070	2
	Bolsa	NO009080	2
<b>NFC-9</b>	L-Box	NC009030	25
	Blister	NC009070	2
	Bolsa	NC009080	2

REF.	ENVASE	COD.	Uds.
<b>NFE-9</b>	L-Box	NE009030	25
	Bolsa	NE009080	2
<b>NFT-12</b>	L-Box	NT012030	25
	Bolsa	NT012080	2
<b>NFA-12</b>	L-Box	NA012030	15
	Bolsa	NA012080	2
<b>NFL-12</b>	L-Box	NL012030	15
	Bolsa	NL012080	2
<b>NFO-12</b>	L-Box	NO012030	15
	Bolsa	NO012080	2
<b>NFC-12</b>	L-Box	NC012030	15
	Bolsa	NC012080	2
<b>NFE-12</b>	L-Box	NE012030	10
	Bolsa	NE012080	2

# NYLON FIX TP

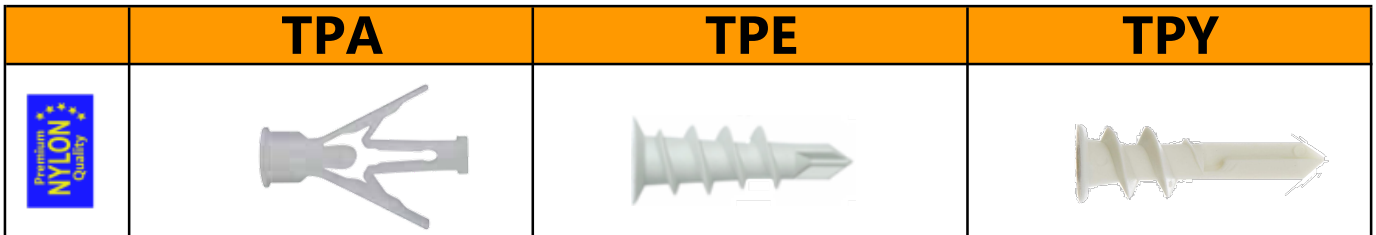

## TPA Tech INFO

### MATERIAL

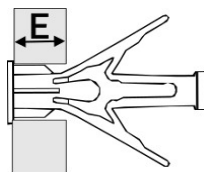
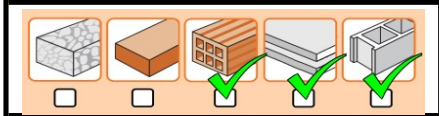

### INSTALACIÓN

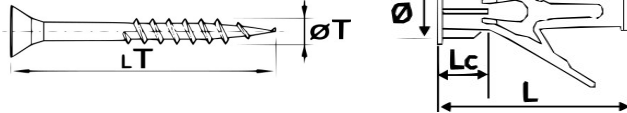
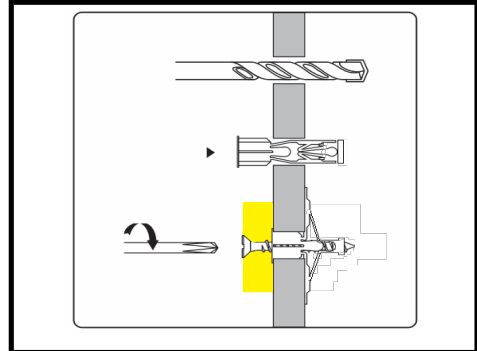

REF.	Ø mm	Lc mm	L mm	E mm	øT	LT min	MAX Kg	MAX Kg	MAX Kg
TPA8S	8	10	40	6 - 13	3,5	40	18	12	20
TPA8L	8	17	40	13 - 20	3,5	50	20	13	21
TPA10S	10	10	38	6 - 13	4	50	22	15	24
TPA10L	10	17	47	13 - 20	4	60	25	17	25

## TPE Tech INFO

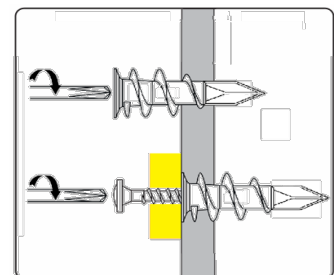
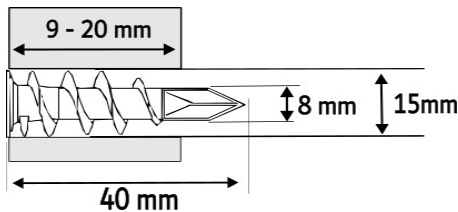
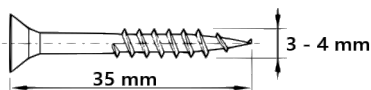



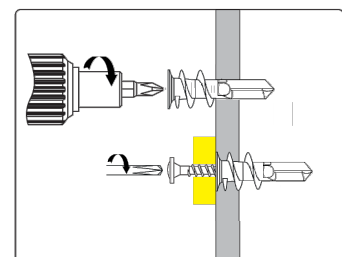
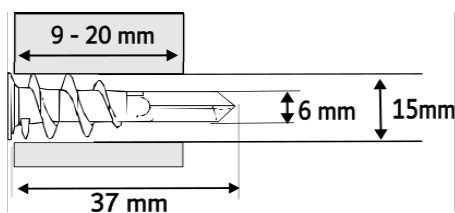
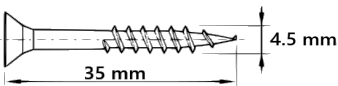

## TPY Tech INFO



# NYLON FIX TP

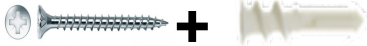

<b>REF.</b>		<b>REF.</b>	
<b>TPA8S</b>	TPA8S	<b>TPA8SZ</b>	TPA8S + PZ 3.5 x 40
<b>TPA8L</b>	TPA8L	<b>TPA8LZ</b>	TPA8L + PZ 3.5 x 50
<b>TPA10</b>	TPA10	<b>TPA10Z</b>	TPA10S + PZ 4 x 50
<b>TPA10L</b>	TPA10L	<b>TPA10LZ</b>	TPA10L + PZ 4 x 60
<b>REF.</b>		<b>REF.</b>	
<b>TPE</b>	TPE	<b>TPEZ</b>	TPE + PZ 3.5 x 35
<b>REF.</b>		<b>REF.</b>	
<b>TPY</b>	TPY	<b>TPYZ</b>	TPY + PZ 4.5 x 35

## TP - PACK

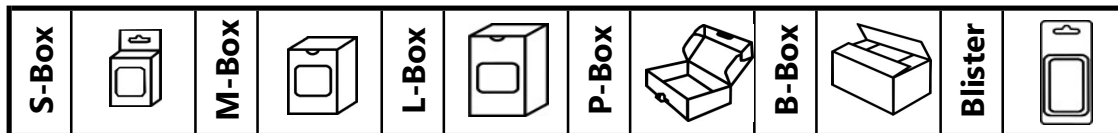

REF.	ENVASE	COD.	Uds.
<b>TPA8S</b>	<b>L-Box</b>	TA810030	60
	<b>P-Box</b>	TA810040	200
	<b>B-Box</b>	TA810050	500
	<b>Blister</b>	TA810070	10
<b>TPA8L</b>	<b>L-Box</b>	TA817030	40
	<b>P-Box</b>	TA817040	100
	<b>B-Box</b>	TA817050	300
	<b>Blister</b>	TA817070	6
<b>TPA8SZ</b>	<b>S-Box</b>	AZ810010	10
	<b>Blister</b>	AZ810070	10
<b>TPA8LZ</b>	<b>S-Box</b>	AZ817010	6
	<b>Blister</b>	AZ817070	6

REF.	ENVASE	COD.	Uds.
<b>TPA10S</b>	<b>L-Box</b>	TA110030	40
	<b>P-Box</b>	TA110040	100
	<b>B-Box</b>	TA110050	500
	<b>Blister</b>	TA110070	6
<b>TPA10L</b>	<b>L-Box</b>	TA117030	40
	<b>P-Box</b>	TA117040	100
	<b>B-Box</b>	TA117050	500
	<b>Blister</b>	TA117070	4
<b>TPA10SZ</b>	<b>M-Box</b>	AZ110020	20
	<b>Blister</b>	AZ110070	6
<b>TPA10LZ</b>	<b>M-Box</b>	AZ117020	20
	<b>Blister</b>	AZ117070	4

<b>TPE</b>	<b>L-Box</b>	TE008030	60
	<b>P-Box</b>	TE008040	150
	<b>B-Box</b>	TE008050	600
	<b>Blister</b>	TE008070	8
<b>TPEZ</b>	<b>S-Box</b>	EZ008010	15
	<b>Blister</b>	EZ008070	4

<b>TPY</b>	<b>L-Box</b>	TY006030	100
	<b>P-Box</b>	TY006040	250
	<b>B-Box</b>	TY006050	600
	<b>Blister</b>	TY006070	8
<b>TPYZ</b>	<b>S-Box</b>	YZ006010	16
	<b>Blister</b>	YZ006070	8

# SCAF FIX TFA



## TFAN

## TFAO

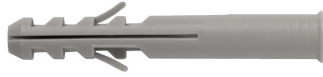
## TFAT

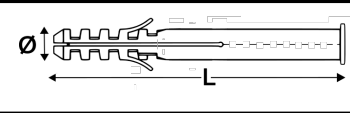

## Tech INFO

REF.				
	Ø mm	L mm		
TFAN100	14	100	145	70
TFAN135	14	135		
TFAN185	14	185		

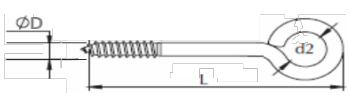
REF.			
	Ø D	L	d2
TFAO120	12	120	23
TFAO160	12	160	23
TFAO190	12	190	23

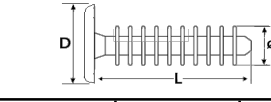
REF.			
	D	L	Ø
TFAT421	21	40	13
TFAT821	21	80	13
TFAT828	28	80	13

## MATERIAL

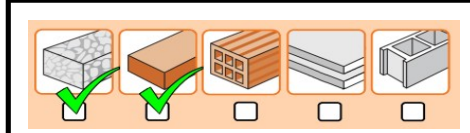

## INSTALACIÓN

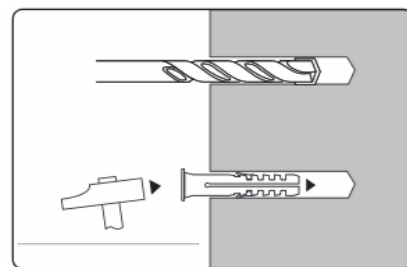

## TFA - PACK

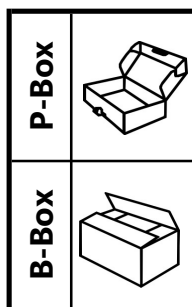

REF.	ENVASE	COD.	Uds
TFAN100	P-Box	TN100040	40
TFAN135	P-Box	TN135040	30
TFAN185	H-Box	TN185060	40
TFAO120	B-Box	TO122050	20
TFAO160	B-Box	TO126050	20
TFAO190	H-Box	TO129060	20
TFAT421	B-Box	TT214050	100
TFAT821	B-Box	TT218050	100
TFAT828	B-Box	TT288050	100

# SCAF FIX TFA



## TFAN

## TFAO

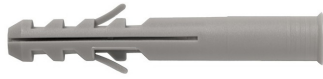
## TFAT

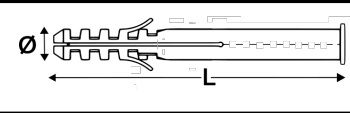

## Tech INFO

REF.				
	Ø mm	L mm		
TFAN100	14	100	145	70
TFAN135	14	135		
TFAN185	14	185		

## MATERIAL

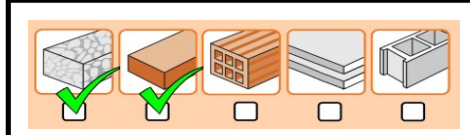

## INSTALACIÓN

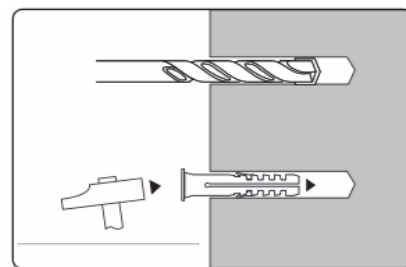

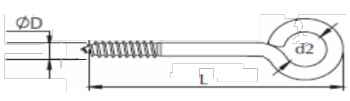
REF.			
	Ø D	L	d2
TFAO120	12	120	23
TFAO160	12	160	23
TFAO190	12	190	23

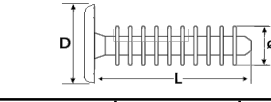
REF.			
	D	L	Ø
TFAT421	21	40	13
TFAT821	21	80	13
TFAT828	28	80	13

# TFA - PACK

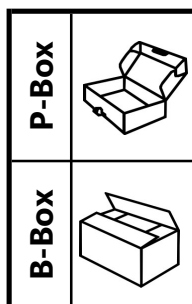

REF.	ENVASE	COD.	Uds
TFAN100	P-Box	TN100040	40
TFAN135	P-Box	TN135040	30
TFAN185	H-Box	TN185060	40
TFAO120	B-Box	TO122050	20
TFAO160	B-Box	TO126050	20
TFAO190	H-Box	TO129060	20
TFAT421	B-Box	TT214050	100
TFAT821	B-Box	TT218050	100
TFAT828	B-Box	TT288050	100

## BRIDA FIX

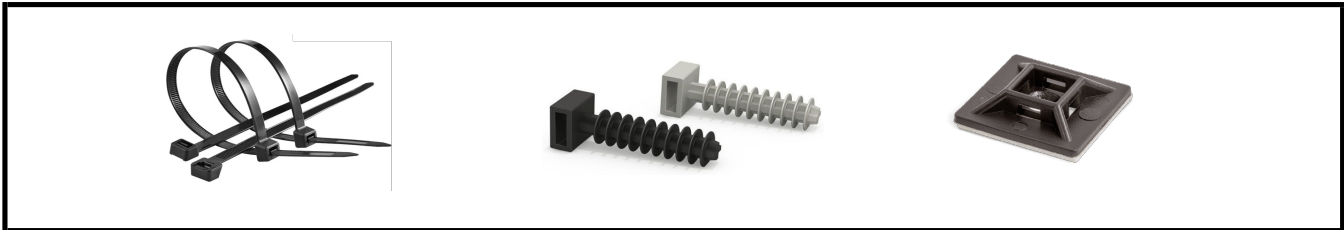

## BRIDAS

## Tech INFO

Material PA66

Temperatura operativa

-40°C to 85°C

Temperatura recomendada de instalación

-10°C to 85°C

Resistencia de calor

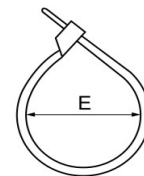
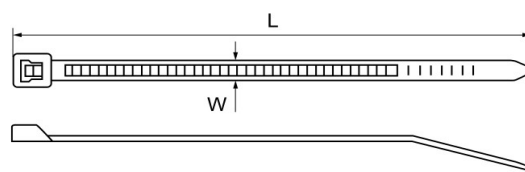

REF	COD.	L	W	E	CARGA	COLOR	BOLSA
					KG		UDS
BF2510N	20F251010	100	2.5	22	8	Black	100
BF2515N	20F251510	150	2.5	35	8	Black	100
BF2520N	20F252010	200	2.5	50	8	Black	100
BF3515N	20F351510	150	3.5	35	18	Black	50
BF3520N	20F352010	200	3.5	50	18	Black	50
BF3520N	20F352010	250	3.5	65	18	Black	50
BF3530N	20F353010	300	3.5	80	18	Black	50
BF3535N	20F353510	350	3.5	90	18	Black	50
BF4520N	20F452010	200	4.5	50	22	Black	50
BF4525N	20F452510	250	4.5	65	22	Black	50
BF4530N	20F453010	300	4.5	80	22	Black	50
BF4535N	20F453510	350	4.5	90	22	Black	50
BF4540N	20F454010	400	4.5	105	22	Black	50
BF4550N	20F455010	500	4.5	150	22	Black	50
BF7530N	20F753010	300	7.5	90	54	Black	25
BF7540N	20F754010	400	7.5	105	54	Black	25
BF7550N	20F755010	500	7.5	150	54	Black	25
BF2510B	20F251020	100	2.5	22	8	White	100
BF2515B	20F251520	150	2.5	35	8	White	100
BF2520B	20F252020	200	2.5	50	8	White	100
BF3515B	20F351520	150	3.5	35	18	White	50
BF3520B	20F352020	200	3.5	50	18	White	50
BF3520B	20F352020	250	3.5	65	18	White	50
BF3530B	20F353020	300	3.5	80	18	White	50
BF3535B	20F353520	350	3.5	90	18	White	50
BF4520B	20F452020	200	4.5	50	22	White	50
BF4525B	20F452520	250	4.5	65	22	White	50
BF4530B	20F453020	300	4.5	80	22	White	50
BF4535B	20F453520	350	4.5	90	22	White	50
BF4540B	20F454020	400	4.5	105	22	White	50
BF4550B	20F455020	500	4.5	150	22	White	50
BF7530B	20F753020	300	7.5	90	54	White	25
BF7540B	20F754020	400	7.5	105	54	White	25
BF7550B	20F755020	500	7.5	150	54	White	25

## BRIDA NYLON ETIQUETAS

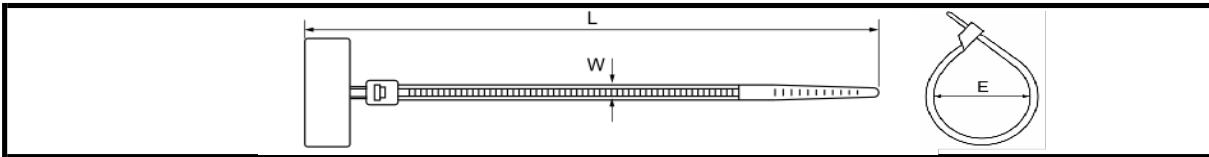

REF	COD.	L	W	E	TENSILE	COLOR	BOLSA
					KG		UDS
BE2511B	BE251120	110	2.5	22	8	White	25
BE3015B	BE301520	150	3	35	11	White	25
BF3020B	BF302020	200	3	50	11	White	25

## BRIDA NYLON CON ABRAZADERA

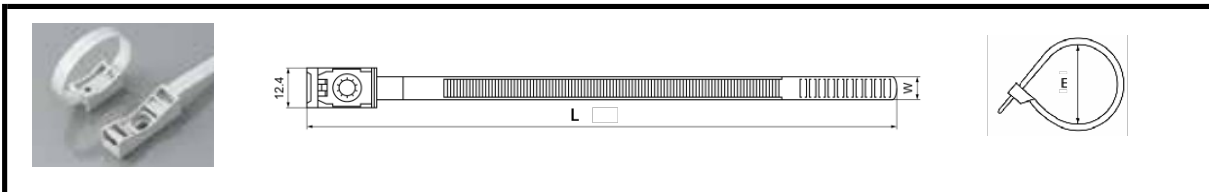

REF	COD.	L	W	E	TENSILE	COLOR	BOLSA
					KG		UDS
BA7516N	BA751610	165	7.5	16 - 32		Black	25
BA7528N	BA752810	285	7.5	32 - 67		Black	25
BA7516B	BA751620	165	7.5	16 - 32		White	25
BA7528B	BA752820	285	7.5	32 - 67		White	25

## TACO Y BASE ADHESIVA BRIDAS

Ref.	BTB				
	L	L1	H	H1	W
<b>BTB6</b>	12.5	9.5	30	6	8
<b>BTB8</b>	14.8	10	34	6	10

REF	COD.	COLOR	BOLSA
			UDS
<b>BTB6N</b>	BT000610	Black	25
<b>BTB8N</b>	BT000810	Black	25
<b>BTB6B</b>	BT000620	White	25
<b>BTB8B</b>	BT000820	White	25

Ref.	BBA			
	L	W	H	D
<b>BBA2A</b>	22	16	9.5	4.5
<b>BBA2B</b>	22	16	9.5	6.8

REF	COD.	COLOR	BOLSA
			UDS
<b>BBA2AN</b>	BB164510	Black	25
<b>BBA2BN</b>	BB166810	Black	25
<b>BBA2AB</b>	BB164520	White	25
<b>BBA2BB</b>	BB166820	White	25

Ref.	BBD			
	L	W	H	T
<b>BBD30</b>	30	30	8.7	64

REF	COD.	COLOR	BOLSA
			UDS
<b>BBD30N</b>	BD303010	Black	25
<b>BBD30B</b>	BD303020	White	25

# CUELGA FIX

## CUELGA FIX CON APLICADOR

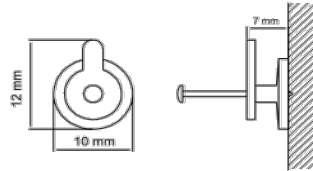

### CUELGA FÁCIL 1 PUNTA 10MM

CÓDIGO	MODELO	UDS	ENVASE
TC0701**	CPS-10	16	BLISTER

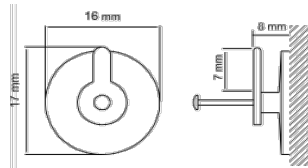

### CUELGA FÁCIL 1 PUNTA 16MM

CÓDIGO	MODELO	UDS	ENVASE
TC0702**	CPB-12	12	BLISTER

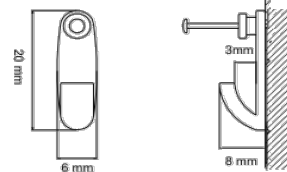

### CUELGA FÁCIL GANCHO

CÓDIGO	MODELO	UDS	ENVASE
TC0703**	CCG-06	16	BLISTER

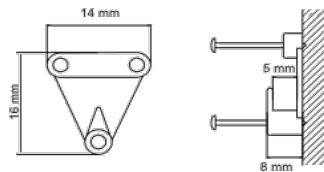

### CUELGA FÁCIL 3 PUNTAS TRIANGULAR

CÓDIGO	MODELO	UDS	ENVASE
TC0704**	CTL-14	10	BLISTER



EASY-FIX

# CUELGA FIX

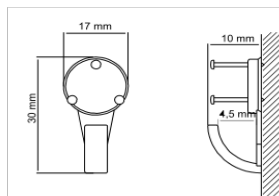

### CUELGA FÁCIL 3 PUNTAS 17 MM

CÓDIGO	MODELO	UDS	ENVASE
TC0705**	CGS-17	8	BLISTER

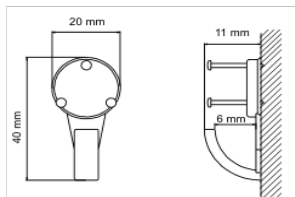

### CUELGA FÁCIL 3 PUNTAS 20 MM

CÓDIGO	MODELO	UDS	ENVASE
TC0706**	CGB-20	6	BLISTER

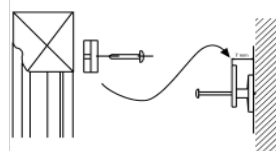

### CUELGA FÁCIL PLANO

CÓDIGO	MODELO	UDS	ENVASE
TC0707**	SPC-1	10	BLISTER

\*\*COLORES: 00 TRANSPARENTE 06 BLANCO

## CUELGA FIX ADHESIVO

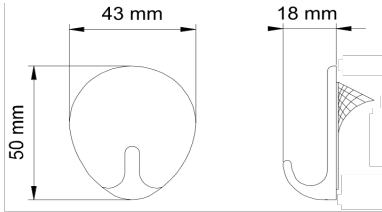

### COLGADOR OVALADO

CÓDIGO	MODELO	UDS	ENVASE
TC0708**	CGO-43	2	BLISTER

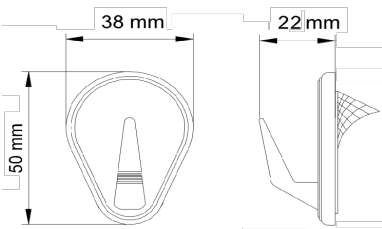

### COLGADOR LÁGRIMA

CÓDIGO	MODELO	UDS	ENVASE
TC0709**	CMO-38	2	BLISTER

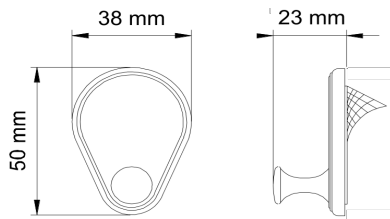

### COLGADOR OVALADO PUNTA REDONDA

CÓDIGO	MODELO	UDS	ENVASE
TC0710**	CMP-38	2	BLISTER

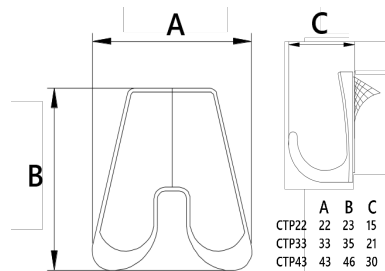

### COLGADOR TRAPEZIO

CÓDIGO	MODELO	UDS	ENVASE
TC0711**	CTP-22	4	BLISTER
TC0712**	CTP-33	2	BLISTER
TC0713**	CTP-43	2	BLISTER

\*\*COLORES: 00 TRANSPARENTE 06 BLANCO 20 ORO

# CORTINAS



## ANILLA ESTOR

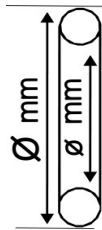

CÓDIGO	MODELO	UDS	ENVASE
TE080100	ASR-6x9	100	BOLSA
TE070100	ASR-6x9	100	BLISTER
TE080200	ASR-8x13	100	BOLSA
TE070200	ASR-8x13	100	BLISTER
TE080300	ASR-11x16	100	BOLSA
TE070300	ASR-11x16	100	BLISTER

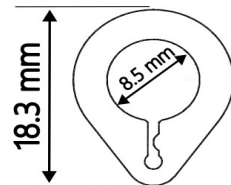

CÓDIGO	MODELO	UDS	ENVASE
TE080400	ASE-18	100	BOLSA
TE070400	ASE-18	100	BLISTER

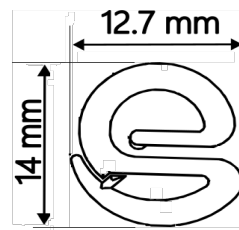

CÓDIGO	MODELO	UDS	ENVASE
TE080500	ASO-14	100	BOLSA
TE070500	ASO-14	100	BLISTER

COLOR: TRANSPARENTE

## CORCHETE CORTINA

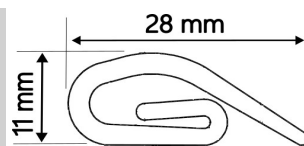

CÓDIGO	MODELO	UDS	ENVASE
TE080600	TCA-28	100	BOLSA
TE070600	TCA-28	40	BLISTER
TE040600	TCA-28	400	P-BOX

COLOR: BLANCO

# TOPE PUERTA

## ADHESIVO SIN RETENEDOR

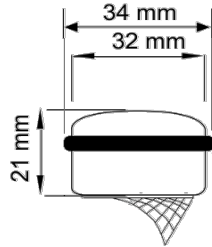

### TRANSPARENTE CON ANILLA DE GOMA

CÓDIGO	MODELO	UDS	ENVASE
TP080100	TPP-32	4	BOLSA
TP070100	TPP-32	2	BLISTER

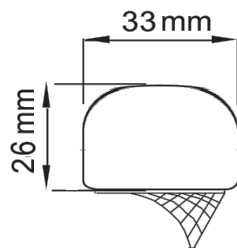

### BOLA

CÓDIGO	MODELO	UDS	ENVASE
TP0802**	TPP-33	4	BOLSA
TP0702**	TPP-33	2	BLISTER

COLORES: 06 BLANCO 09 GRIS  
10 MARRÓN 12 NEGRO 13 BEIGE

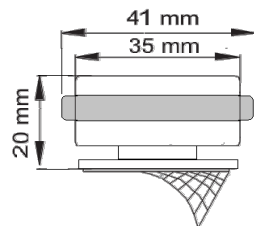

### REDONDO

#### SIN ANILLA DE GOMA

CÓDIGO	MODELO	UDS	ENVASE
TP0803**	TPP-41	4	BOLSA
TP0703**	TPP-41	2	BLISTER



COLORES: 06 BLANCO  
09 GRIS 10 MARRÓN  
12 NEGRO 13 BEIGE  
00 TRANSPARENTE

#### CON ANILLAS DE GOMA

CÓDIGO	MODELO	UDS	ENVASE
TP0804**	TPP-30	4	BOLSA
TP0704**	TPP-30	2	BLISTER

## ADHESIVO CON RETENEDOR

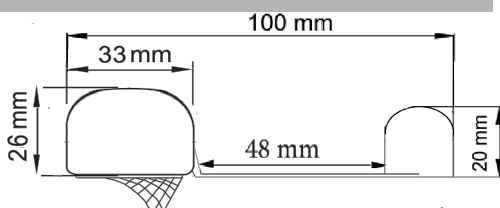

### BOLA

CÓDIGO	MODELO	UDS	ENVASE
TP0805**	TPB-100	4	BOLSA
TP0705**	TPB-100	2	BLISTER

COLORES: 06 BLANCO 09 GRIS  
10 MARRÓN 12 NEGRO 13 BEIGE

### RETENEDOR DESMONTABLE

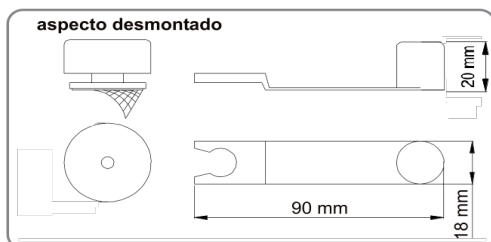

### SIN ANILLA DE GOMA

CÓDIGO	MODELO	UDS	ENVASE
TP0806**	TPC-100	4	BOLSA
TP0706**	TPC-100	2	BLISTER

### CON ANILLA DE GOMA

CÓDIGO	MODELO	UDS	ENVASE
TP0807**	TPG-100	4	BOLSA
TP0707**	TPG-100	2	BLISTER

COLORES: 06 BLANCO 09 GRIS  
10 MARRÓN 12 NEGRO 13 BEIGE  
00 TRANSPARENTE

## ATORNILLABLE



### REDONDO

#### SIN ANILLA DE GOMA

CÓDIGO	MODELO	UDS	ENVASE
TP0808**	TPA-41	4	BOLSA
TP0708**	TPA-41	2	BLISTER

#### CON ANILLA DE GOMA

CÓDIGO	MODELO	UDS	ENVASE
TP0809**	TPA-100	4	BOLSA
TP0709**	TPA-100	2	BLISTER

### RETENEDOR DESMONTABLE

#### SIN ANILLA DE GOMA

CÓDIGO	MODELO	UDS	ENVASE
TP0810**	TGA-100	4	BOLSA
TP0710**	TGA-100	2	BLISTER

#### CON ANILLA DE GOMA

CÓDIGO	MODELO	UDS	ENVASE
TP0811**	TGR-100	4	BOLSA
TP0711**	TGR-100	2	BLISTER

### RETENEDOR DESMONTABLE

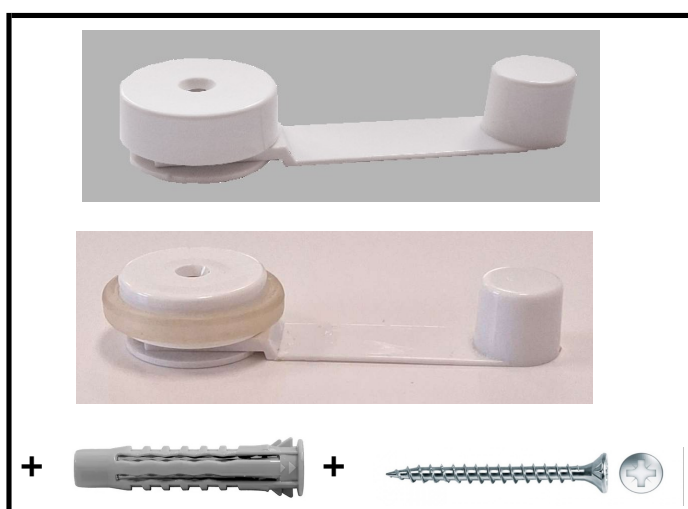
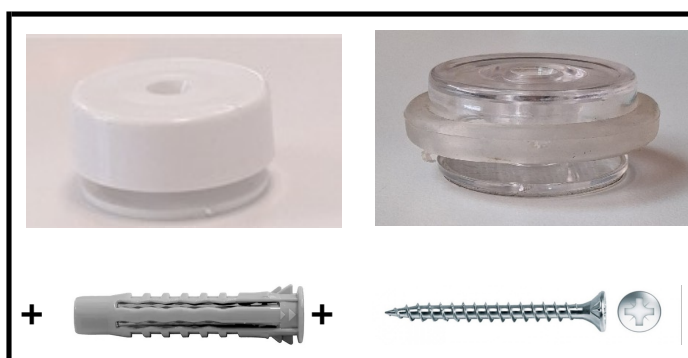

COLORES: 06 BLANCO 09 GRIS  
10 MARRÓN 12 NEGRO 13 BEIGE

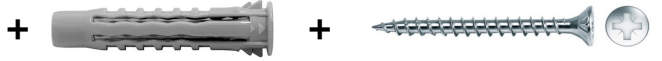
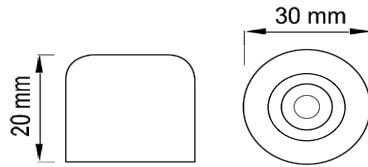

### GOMA

CÓDIGO	MODELO	UDS	ENVASE
TP0812**	TPV-30	4	BOLSA
TP0712**	TPV-30	2	BLISTER

COLORES: 06 BLANCO 09 GRIS  
10 MARRÓN 12 NEGRO 13 BEIGE

### PARED

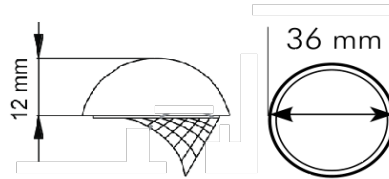

CÓDIGO	MODELO	UDS	ENVASE
TP081300	TPP-36	4	BOLSA
TP071300	TPP-36	2	BLISTER

COLORES: 06 BLANCO 09 GRIS

### TOPE PUERTA MANILLA TRANSPARENTE

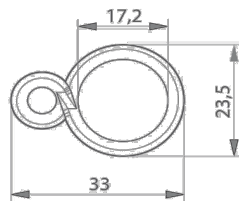

#### TOPE PUERTA MANILLA 1 ANILLA

CÓDIGO	MODELO	UDS	ENVASE
TP081400	TPA-1	8	BOLSA
TP071400	TPA-1	4	BLISTER

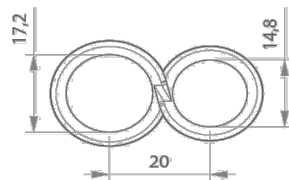

#### TOPE PUERTA MANILLA 2 ANILLAS

CÓDIGO	MODELO	UDS	ENVASE
TP081500	TPA-2	8	BOLSA
TP071500	TPA-2	4	BLISTER

### CUÑA

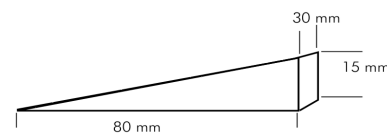

#### CUÑA PLÁSTICO

CÓDIGO	MODELO	UDS	ENVASE
TP0816**	TPC-80	6	BOLSA
TP0716**	TPC-80	2	BLISTER

COLORES: 03 AMARILLO 06 BLANCO  
09 GRIS 10 MARRÓN 11 ROJO 12 NEGRO

#### CUÑA GOMA

CÓDIGO	MODELO	UDS	ENVASE
TP0817**	TPC-81	4	BOLSA
TP0717**	TPC-81	2	BLISTER

COLORES: 06 BLANCO 09 GRIS  
00 TRANSPARENTE

# PROTECTOR ADHESIVO



## FIELTRO

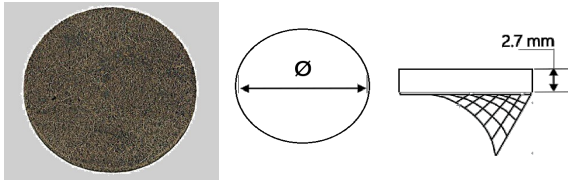

CÓDIGO	MODELO	UDS.	ENVASE
	MR - Ø		
TF083510	FMR-16	16	BOLSA
TF083610	FMR-22	12	BOLSA
TF083710	FMR-24	12	BOLSA
TF083810	FMR-30	6	BOLSA

COLOR: MARRÓN

## LAGRIMA REDONDA SILICONA

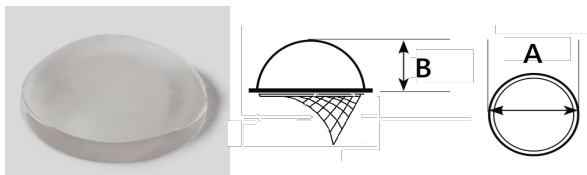

CÓDIGO	MODELO	UDS	PACK
	LTR (A)		
TF082500	LTR-7x1,5	50	BOLSA
TF082600	LTR-10x3	100	BOLSA

COLOR: TRANSPARENTE

## LÁGRIMA HEMISFÉRICA SILICONA

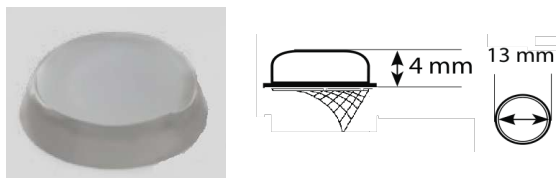

CÓDIGO	MODELO	UDS	PACK
TF082700	LTH-13x4	40	BOLSA

COLOR: TRANSPARENTE

## LÁGRIMA CUADRADA SILICONA

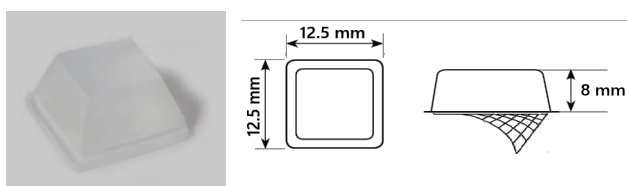

CÓDIGO	MODELO	UDS	PACK
TF082800	LTC-12.5	80	BOLSA

COLOR: TRANSPARENTE

# VARIOS



## TOPE PERSIANA

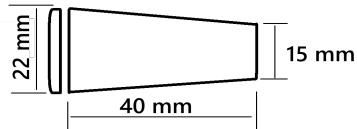
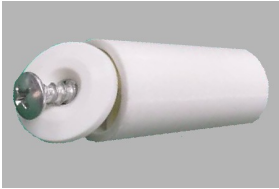

CÓDIGO	MODELO	UDS	ENVASE
TV0801**	PMS-100	2	BOLSA
TV0701**	PMS-100	2	BLISTER

\*\* COLORES 06 BLANCO 09 GRIS  
14 ANTRACITA

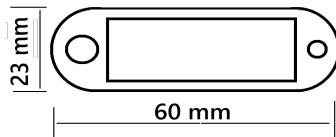

## LLAVERO PORTAETIQUETAS CON ANILLA

CÓDIGO	MODELO	UDS	ENVASE
TV0802**	LPE - 60	50	BOLSA
TV0402**	LPE - 60	100	P-BOX

\*\* COLORES 01 AZUL 02 AZUL MARINO 03 AMARILLO 04 VERDE 05 VERDE CLARO  
06 BLANCO 07 NARANJA 08 ROSA 09 GRIS 11 ROJO 12 NEGRO 18 VIOLETA 40 COLORES MEZCLADOS

## ANILLA LLAVERO

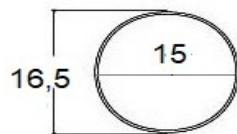

CÓDIGO	MODELO	UDS	ENVASE
TV0803**	ARL-165	100	BOLSA
TV0404**	ARL-165	1.000	P-BOX

## CLIP HERMÉTICO

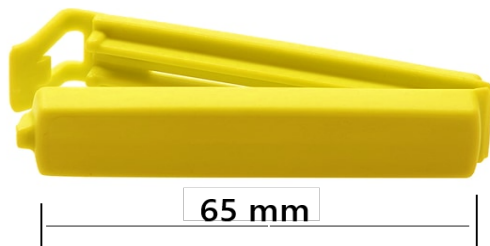

CÓDIGO	MODELO	UDS	ENVASE
TV0805**	CPB-10	5	BOLSA

\*\* COLORES 01 AZUL 03 AMARILLO 04 VERDE  
06 BLANCO 11 ROJO 40 COLORES MEZCLADOS

## SUJETAMANTELES

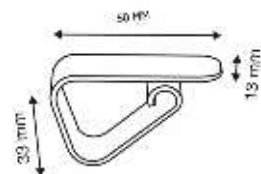

CÓDIGO	MODELO	UDS	ENVASE
TV0806**	SME - 55	10	BOLSA
TV0407**	SME - 55	50	P-BOX

\*\* COLORES 00 TRANSPARENTE 06 BLANCO  
10 MARRÓN 12 NEGRO 20 ORO

## PROTECCIÓN INFANTIL & MAYORES



### PROTECTOR PUERTA

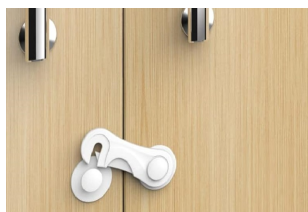
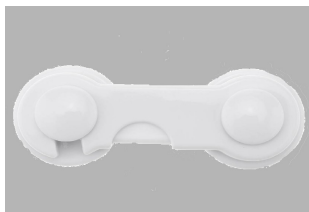

CÓDIGO	MODELO	UDS	ENVASE
TI080106	PMS-100	2	BOLSA
TI070106	PMS-100	2	BLISTER

FIJACIÓN ADHESIVO COLOR: BLANCO

### PROTECTOR AJUSTABLE PUERTA

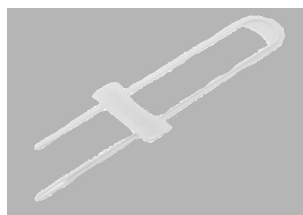

CÓDIGO	MODELO	UDS	ENVASE
TI080206	PMB-100	1	BOLSA

FIJACIÓN ADHESIVO COLOR: BLANCO

### PROTECTOR LATERAL MUEBLE

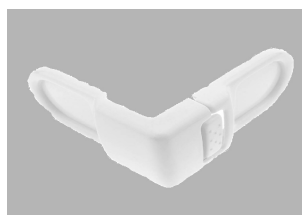

CÓDIGO	MODELO	UDS	ENVASE
TI0803**	PME-100	2	BOLSA
TI0703**	PME-100	1	BLISTER

FIJACIÓN ADHESIVO \*\* COLORES: 06 BLANCO

\*\* 09 GRIS 00 TRANSPARENTE

### PROTECTOR INTERIOR CAJÓN

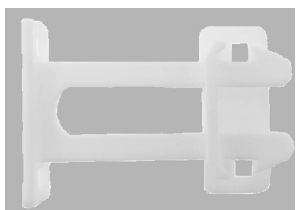

CÓDIGO	MODELO	UDS	ENVASE
TI080406	PMV-90	1	BOLSA
TI070406	PMA-90	1	BOLSA

PMV FIJACIÓN ADHESIVO COLOR: BLANCO

PMA FIJACIÓN TORNILLO COLOR: BLANCO

### PROTECTOR WC

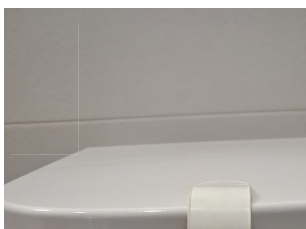

CÓDIGO	MODELO	UDS	ENVASE
TI080506	PMR-100	2	BOLSA

FIJACIÓN ADHESIVO COLOR: BLANCO

## PROTECCIÓN INFANTIL & MAYORES



### PROTECTOR ESQUINA MESA



PEM 50 26 x 19 mm  
PEM 100 35 x 24 MM

CÓDIGO	MODELO	UDS	ENVASE
TI0806**	PEM-50	8	BOLSA
TI0706**	PEM-50	4	BLISTER
TI0807**	PEM-100	8	BOLSA
TI0707**	PEM-100	4	BLISTER

FIJACIÓN ADHESIVO

\*\* COLORES: 06 BLANCO 00 TRANSPARENTE

### PROTECTOR VENTANA



CÓDIGO	MODELO	UDS	ENVASE
TI080806	PMA100	1	BOLSA

FIJACIÓN ADHESIVO COLOR: BLANCO

# CONTERA

## CONTERA EXTERIOR GOMA

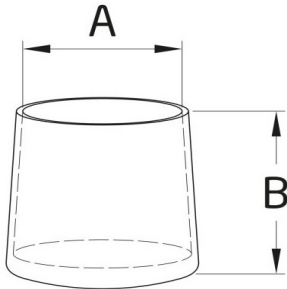

CÓDIGO	MODELO	MEDIDAS		UDS	ENVASE
		A	B		
CG080112	CEG-8	8	32	8	BOLSA
CG080212	CEG-10	10	32	8	BOLSA
CG080312	CEG-12	12	32	8	BOLSA
CG080412	CEG-14	14	32	8	BOLSA
CG080512	CEG-15	15	32	8	BOLSA
CG080612	CEG-16	16	32	4	BOLSA
CG080712	CEG-18	18	32	4	BOLSA
CG100812	CEG-20	20	32	50	BOLSA
CG100912	CEG-22	22	32	50	BOLSA
CG101012	CEG-24	24	32	50	BOLSA
CG101112	CEG-25	25	32	50	BOLSA
CG101212	CEG-26	26	32	50	BOLSA
CG101312	CEG-30	30	32	50	BOLSA
CG101412	CEG-32	32	32	50	BOLSA

## CONTERA GOMA MULETA CON ARANDELA METAL

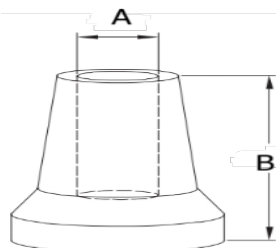

CÓDIGO	MODELO	MEDIDAS		UDS	ENVASE
		A	B		
CG081512	CGM-18	18	50	2	BOLSA
CG081612	CGM-20	20	50	2	BOLSA
CG101512	CGM-18	18	50	25	BOLSA
CG101612	CGM-20	20	50	25	BOLSA

## CONTERA INTERIOR CUADRADA

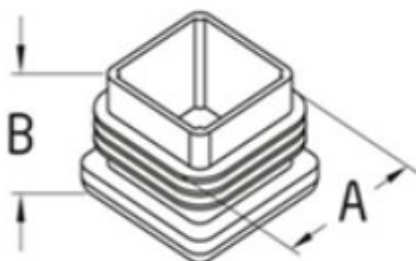

CÓDIGO	MODELO	MEDIDAS		UDS	ENVASE
		A	B		
CP080112	CIC-14	14	17,5	8	BOLSA
CP080212	CIC-16	16	21	8	BOLSA
CP080312	CIC-18	18	21	4	BOLSA
CP080412	CIC-20	20	23	4	BOLSA
CP080512	CIC-25	25	26	4	BOLSA
CP080612	CIC-30	30	26	4	BOLSA
CP080712	CIC-35	35	26	4	BOLSA
CP080812	CIC-40	40	25	4	BOLSA
CP080912	CIC-45	45	26	4	BOLSA
CP081012	CIC-50	50	25	4	BOLSA
CP101112	CIC-60	60	25	50	BOLSA
CP101212	CIC-70	70	21	50	BOLSA
CP101312	CIC-80	80	26	25	BOLSA
CP101412	CIC-90	90	25	25	BOLSA
CP101512	CIC-100	100	25	25	BOLSA
CP101612	CIC-110	110	27	25	BOLSA
CP101712	CIC-120	120	26,5	25	BOLSA

## CONTERA INTERIOR REDONDA

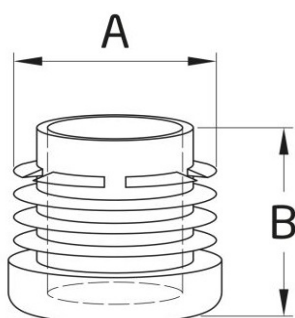

CÓDIGO	MODELO	MEDIDAS		UDS	ENVASE
		A	B		
CO081812	CIR-12	12	17,5	8	BOLSA
CP081912	CIR-14	14	17,5	8	BOLSA
CP082012	CIR-16	16	22	8	BOLSA
CP082112	CIR-18	18	24,5	4	BOLSA
CP082212	CIR-20	20	28,5	4	BOLSA
CP082312	CIR-22	22	27,5	4	BOLSA
CP082412	CIR-25	25	27,5	4	BOLSA
CP082512	CIR-28	28	28,5	4	BOLSA
CP082612	CIR-30	30	28,5	4	BOLSA
CP102712	CIR-35	35	25	100	BOLSA
CP102812	CIR-40	40	25	100	BOLSA
CP102912	CIR-45	45	25	100	BOLSA
CP103012	CIR-50	50	24	100	BOLSA
CP103112	CIR-60	60	25	100	BOLSA
CP103212	CIR-80	80	25	50	BOLSA
CP103312	CIR-90	90	22	25	BOLSA
CP103412	CIR-100	100	22	25	BOLSA
CP103512	CIR-120	120	26,5	25	BOLSA

## CONTERA INTERIOR RECTANGULAR

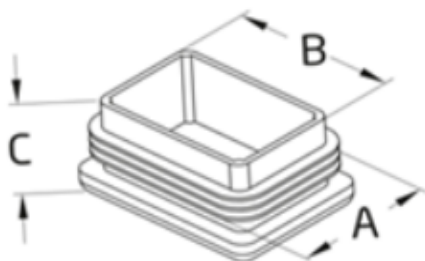

CÓDIGO	MODELO	MEDIDAS			UDS	ENVASE
		A	B	C		
CP083612	CRI-10X30	10	30	19	8	BOLSA
CP083712	CRI-10X40	10	40	22	8	BOLSA
CP083812	CRI-15X30	15	30	21	8	BOLSA
CP083912	CRI-15X25	15	25	15	8	BOLSA
CP084012	CRI-15X40	15	40	15	8	BOLSA
CP084112	CRI-20X30	20	30	21	8	BOLSA
CP084212	CRI-20X40	20	40	22,5	8	BOLSA
CP104312	CRI-20X50	20	50	21	100	BOLSA
CP104412	CRI-20X60	20	60	21	100	BOLSA
CP104512	CRI-20X80	20	80	22	100	BOLSA
CP104612	CRI-20X100	20	100	27	100	BOLSA
CP104712	CRI-25X40	25	40	22	100	BOLSA
CP104812	CRI-30X40	30	40	21	100	BOLSA
CP104912	CRI-30X50	30	50	24	100	BOLSA
CP105012	CRI-30X60	30	60	24,5	100	BOLSA
CP105112	CRI-40X50	40	50	24	100	BOLSA
CP105212	CRI-40X60	40	60	25	100	BOLSA
CP105312	CRI-40X80	40	80	24,5	100	BOLSA
CP105412	CRI-40X100	40	100	23,5	50	BOLSA
CP105512	CRI-40X120	40	120	25	50	BOLSA
CP105612	CRI-50X80	50	80	25	50	BOLSA
CP105712	CRI-50X100	50	100	24,5	50	BOLSA
CP105812	CRI-60X80	60	80	25	50	BOLSA
CP105912	CRI-60X120	60	120	25	25	BOLSA

## CONTERA INTERIOR CUADRADA CON ROSCA

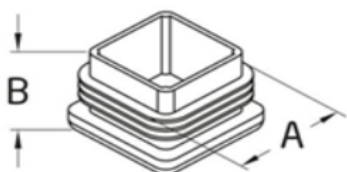

CÓDIGO	MODELO	MEDIDAS		UDS	ENVASE
		A	B		
CR080112	CCR-20 M.8	20	25,50	4	BOLSA
CR080212	CCR-25 M.8	25	25,50	4	BOLSA
CR080312	CCR-25 M.10	25	25,50	4	BOLSA
CR080412	CCR-30 M.8	30	25,50	4	BOLSA
CR080512	CCR-30 M.10	30	25,50	4	BOLSA
CR100112	CCR-20 M.8	20	25,50	50	BOLSA
CR100212	CCR-25 M.8	25	25,50	50	BOLSA
CR100312	CCR-25 M.10	25	25,50	50	BOLSA
CR100412	CCR-30 M.8	30	25,50	50	BOLSA
CR100512	CCR-30 M.10	30	25,50	50	BOLSA

# PIE NIVELADOR



**PNM**



CÓDIGO	MODELO	MEDIDAS			UDS	ENVASE
		A	B	C		
PN080112	PNM-30X40 M.8	30	40,00	20	4	BOLSA
PN080212	PNM-40X45 M.10	38	48,00	34	4	BOLSA
PN080312	PNM-40X58 M.10	40	58,00	30	4	BOLSA
PN100112	PNM-30X40 M.8	30	40,00	20	50	BOLSA
PN100212	PNM-40X45 M.10	38	48,00	34	50	BOLSA
PN100312	PNM-40X58 M.10	40	58,00	30	50	BOLSA

**PNV**

